

Varenummer: 231111231
Beskrivelse: E+G Vertikal søjleoliestandsglas
HCL-500-M12

Mål

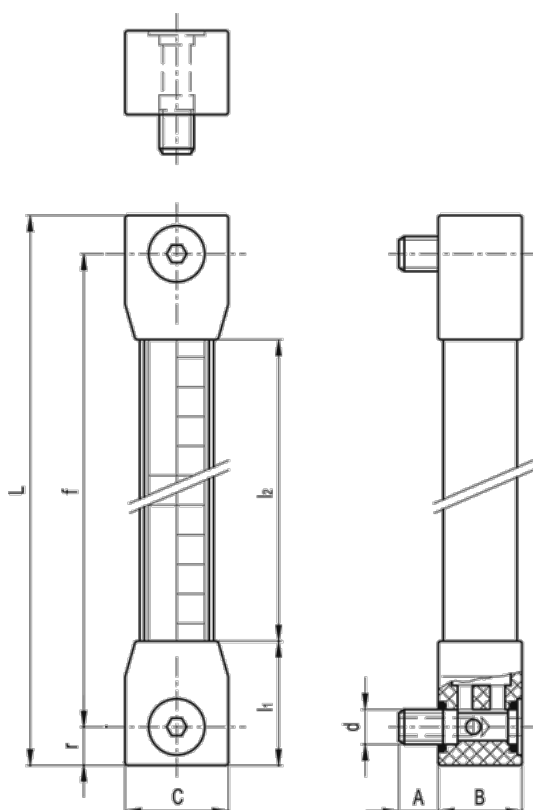

A = 13.5	r = 13
B = 28.5	Vægt (g) = 306
C = 35	
d = M12	
f = 500	
L = 526	
l1 = 42	
l2 = 442	